

Silicon PNP Power Transistors

2SB816

DESCRIPTION

- With TO-3PN package
- Complement to type 2SD1046
- Wide area of safe operation

APPLICATIONS

- For LF Power Amplifier, 50W Output
- Large Power Switching Applications

PINNING

PIN	DESCRIPTION
1	Base
2	Collector;connected to mounting base
3	Emitter

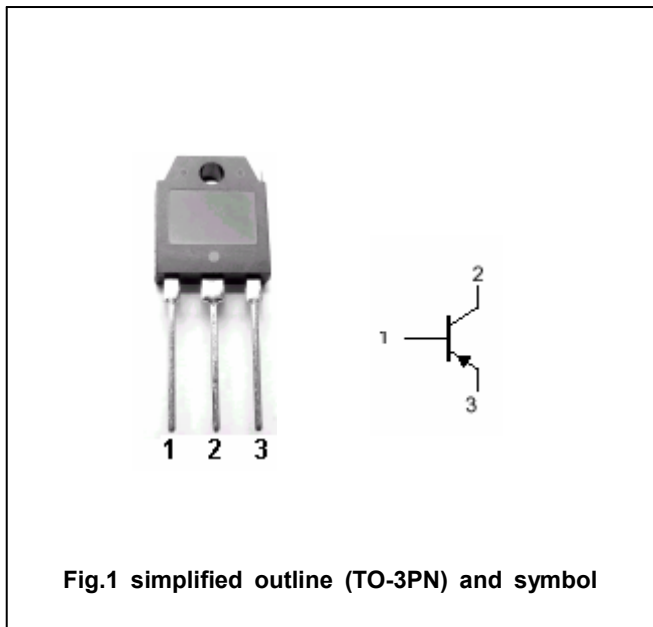

Fig.1 simplified outline (TO-3PN) and symbol

Absolute maximum ratings(Tc=25°C)

SYMBOL	PARAMETER	CONDITIONS	VALUE	UNIT
V _{CBO}	Collector-base voltage	Open emitter	-150	V
V _{CEO}	Collector-emitter voltage	Open base	-120	V
V _{EBO}	Emitter-base voltage	Open collector	-6	V
I _C	Collector current		-8	A
I _{CP}	Collector current-peak		-12	A
P _C	Collector power dissipation	T _C =25°C	80	W
T _j	Junction temperature		150	°C
T _{stg}	Storage temperature		-40~150	°C

Silicon PNP Power Transistors

2SB816

CHARACTERISTICS

T_j=25°C unless otherwise specified

SYMBOL	PARAMETER	CONDITIONS	MIN	TYP.	MAX	UNIT
V _{(BR)CEO}	Collector-emitter breakdown voltage	I _C =-50mA ; R _{BE} =∞	-120			V
V _{(BR)CBO}	Collector-base breakdown voltage	I _C =-5mA ; I _E =0	-150			V
V _{(BR)EBO}	Emitter-base breakdown voltage	I _E =-5mA ; I _C =0	-6			V
V _{CEsat}	Collector-emitter saturation voltage	I _C =-5A ; I _B =-0.5A		-1.0	-2.0	V
V _{BE}	Base-emitter on voltage	I _C =-1A ; V _{CE} =-5V			-1.5	V
I _{CBO}	Collector cut-off current	V _{CB} =-80V ; I _E =0			-0.1	mA
I _{EBO}	Emitter cut-off current	V _{EB} =-4V ; I _C =0			-0.1	mA
h _{FE-1}	DC current gain	I _C =-1A ; V _{CE} =-5V	60		200	
h _{FE-2}	DC current gain	I _C =-5A ; V _{CE} =-5V	20			
f _T	Transition frequency	I _C =-1A ; V _{CE} =-5V		15		MHz
C _{OB}	Collector output capacitance	f=1MHz ; V _{CB} =-10V		220		pF

Switching times

t _{on}	Turn-on time	I _C =-1.0A ; I _{B1} =-I _{B2} =-0.1A V _{CC} =20V ; R _L =20Ω		0.22		μs
t _{stg}	Storage time			0.93		μs
t _f	Fall time			0.37		μs

◆ h_{FE-1} Classifications

D	E
60-120	100-200

Silicon PNP Power Transistors

2SB816

PACKAGE OUTLINE

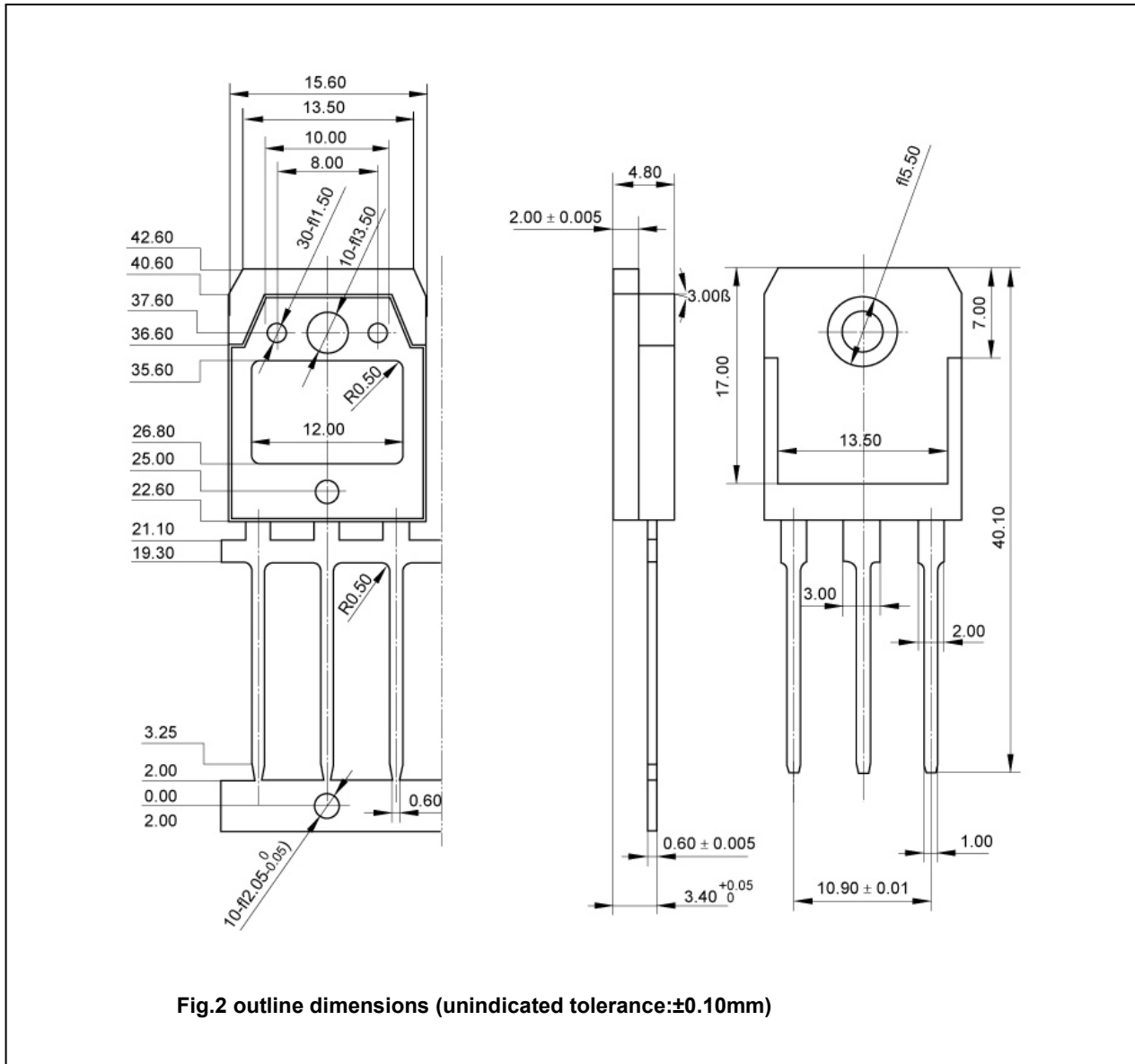

Silicon PNP Power Transistors

2SB816

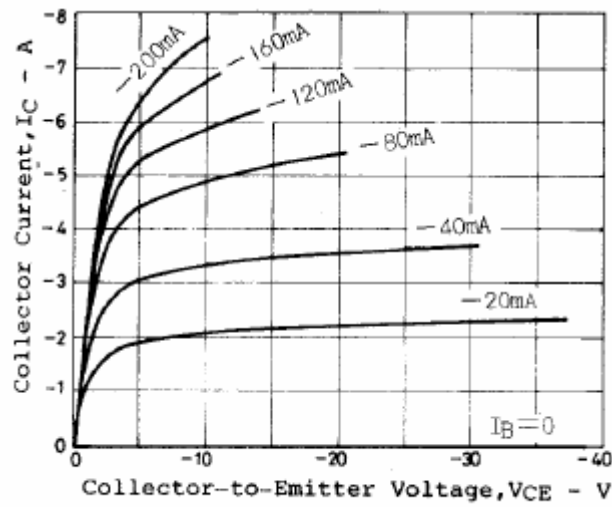

Fig.3 Static Characteristic

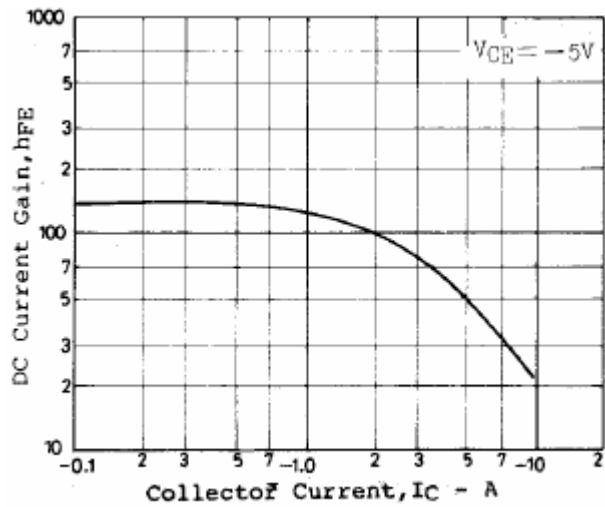

Fig.4 DC current Gain

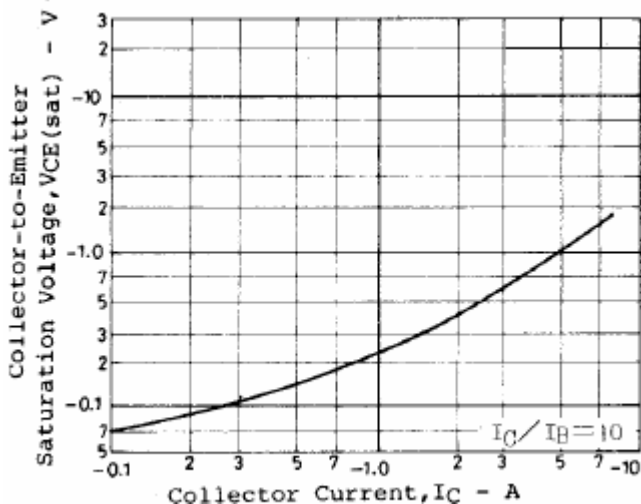

Fig.5 Collector-Emmitter Saturation Voltage

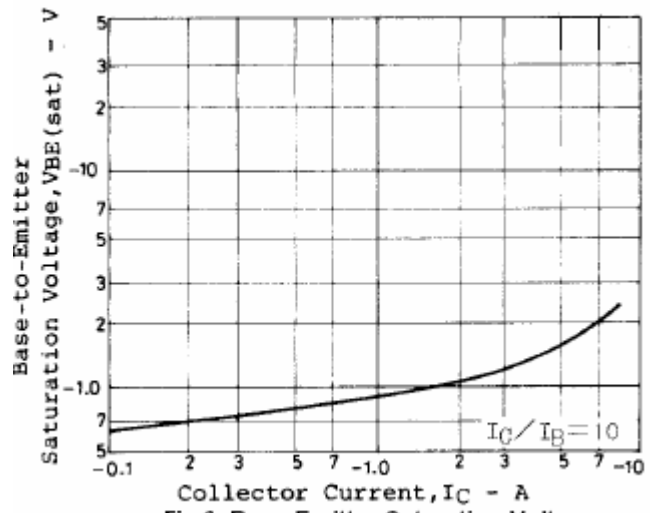

Fig.6 Base-Emmitter Saturation Voltage

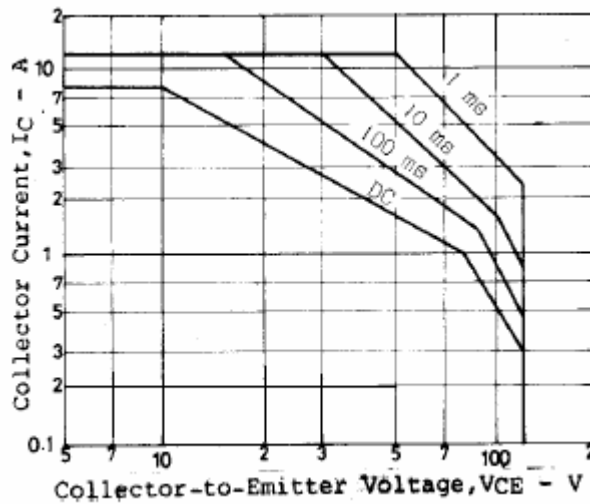

Fig.7 Safe Operating Area